

LINEAR GRATE SHOWER BASE

INSTALLATION GUIDE



IMPORTANT INFO

THIS GUIDE

This document is a guide only and does not cover all unforeseen onsite circumstances. The information within this guide is designed to assist with installation of the systems. A tradesman, builder or DIY'er must draw on trade skill/knowledge to overcome onsite challenges that are not covered within this document as not all variants of site preparation can be predicted or covered.

THE SYSTEM

ISB (Insitu Shower Base) and IPS (Insitu Panelling System) are a fully customizable precision made panelling systems designed to eliminate the use of sand and cement screeds. The weight reduction is of great benefit in relation to overcoming structural engineering challenges and compliment light weight construction. All ISB and IPS panels are constructed of a light weight water resistant formulation and are CNC machined to millimetre perfect dimensions including fall ratios that meet and often far exceed Australian Standard requirements. The panels are able to be manufactured in a range of profile thicknesses and are available in an advanced 'click' system to cover large areas. Demtech offer these technologically advance panelling systems in a variety of 'centre/off-centre' and linear grate style finishes. A factory protective coat of Cureflex SLR2000 is applied to each panel before dispatch (this does not form any part of the required waterproofing system to be applied after panel installation is complete). The ISB and IPS dramatically reduce onsite down time as they are fully cured in an average 48 hours (temperature dependant). Both Demtech ISB and IPS can be installed and waterproofed in the same day and allowed to cure as a complete system (application dependant).

All ISB, IPS and WP systems are tried and tested and are BRANZ approved including all Insitu, Cureflex and Nero product ranges. Nero products are all WaterMarked and meet Australian standard requirements.

RECOMMENDATIONS

All ISB and IPS systems both internal and external require a full liquid membrane system applied over them once installed and cured. These waterproofing systems must meet the Australian Standards 'AS3740 for internal and AS4654 for external. Waterproofing systems applied over the ISB and IPS systems should utilize water based acrylic products. The Demtech ISB and IPS system is not a waterproof system in its self but can be made water tight through correct and thorough installation processes. Products that are tried and tested and have attained a full BRANZ approval for waterproofing application over ISB and IPS systems can be found in our Cureflex and Trims 'n' Finishes range. It is the responsibility of the builder, tradesman or user to ensure that all substrates and structures constructed/installed prior to installation of the Demtech ISB and IPS systems are compliant with the Australian Standards requirement, building codes and are constructed/installed in accordance to all manufacturers' recommendations. ISB and IPS are not 'self-supporting' (non-structural) and require standard flooring structures both internally and externally that comply with all building codes, Australian Standards and manufacturer's recommendations.

WARRANTY

The products supplied in the Demtech ISB and IPS systems as well as materials are covered under a factory product warranty. That is that the products themselves are supplied without manufacturing fault from factory. Workmanship including installation and modification of the Demtech ISB and IPS systems is not covered by Demtech as a manufacturer of the products. This warranty responsibility and obligation is held by the party completing the installation and or modification of the systems supplied. Demtech take no responsibility for workmanship or installation of these systems completed by third party persons.

For further information on our products, systems and services visit our website at www.demtech.com.au

WHAT'S REQUIRED

01. Aluminium Collars
02. Insitu™ Shower Base
03. Aquaflo™ Linear Water Grate
04. Nero™ Sleeve & Grommet *OR* Nero™ Sleeve Extension & Grommet
05. Protective Matting
06. PVC Flashing
07. Hob Waterstops *OR* Aluminium Waterstops
08. Barrier Tape
09. Cureflex™ HV124 Silane
10. Cureflex™ PG57 Primer
11. Cureflex™ TX88 Tile Adhesive
12. Drill Guide
13. Warning Sign
14. 51mm & 83mm Hole Saws
14. 5.5mm Drill Bit
14. Arbour Drill Bit
15. 75mm Wood Screws
15. 75mm Hex Drive Screws
15. 25mm Wood Screws
15. Deburring Tool

01. Caulking Gun
02. Cordless Drill
03. Dustpan & Brush
04. 600/900/1200mm Level
05. Mixing Drill/Attachment
06. Paint Roller (230mm max.)
07. Paint Brush (100mm max.)
08. PH2 Driver Drill Bit
09. Pencil/Marker
10. Small Handsaw
11. Spatula
12. Tinsnips
13. Utility Knife
14. 12mm Notched Trowel
15. 5.5mm Hex Drive Drill Bit
15. 10mm Punch Tool
17. Hammer
18. Chisel

LINEAR GRATE SHOWER BASE

WHAT'S REQUIRED



LINEAR GRATE SHOWER BASE

HOB WATERSTOP

HOB WATERSTOP DESIGN VARIATION

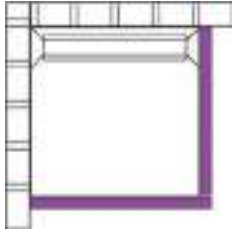

01.

Two walls, two hob waterstops.

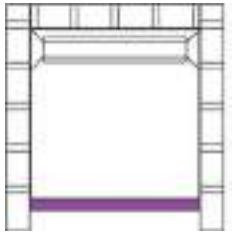

02.

Three walls, one hob waterstop.

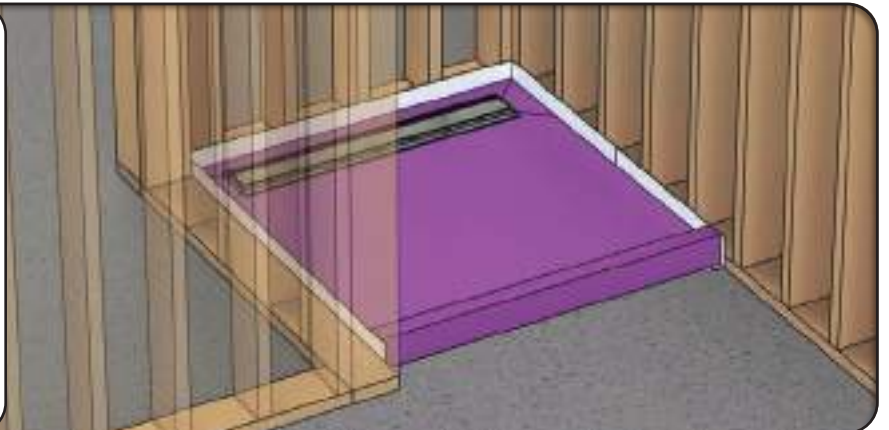

03.

In some cases, hob waterstops can be butted together to complete the shower base perimeter, as shown here.

In these cases, always apply silane between the adjoining faces of the hob waterstops.

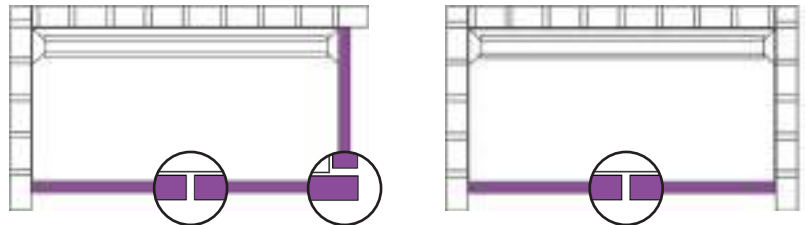

LINEAR GRATE SHOWER BASE

ALUMINIUM WATERSTOP

ALUMINIUM WATERSTOP DESIGN VARIATION

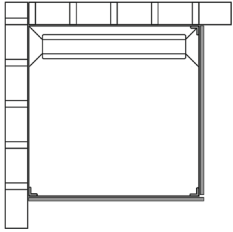

01.

Two walls, two aluminium waterstops.

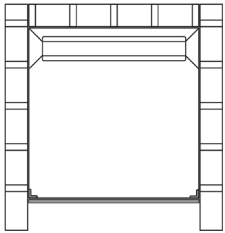

02.

Three walls, one aluminium waterstop.

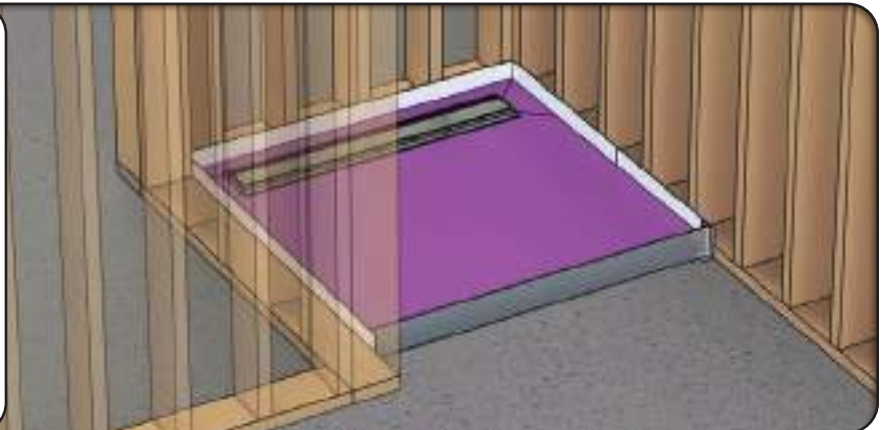

03.

Aluminium collars are required in corners where aluminium waterstop is present.

In some cases, a longer piece of aluminium waterstop may be required to complete the shower base perimeter, as shown here.

Aluminium waterstop is never to be butted together or overlapped, except in the corners of the shower base.

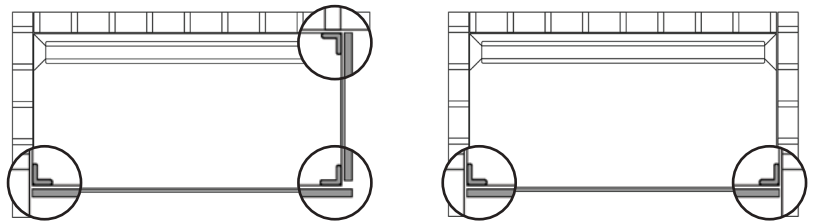

04.

INSTALLATION STEPS

01.

Thoroughly clear the area of any debris to ensure a clean, dust free surface.

Check that the area is level before commencing any works (**3mm** max. height variation across area).



02.

Dry fit the shower base and mark around the perimeter with a pencil or marker.

If the shower base is made up of multiple panels, ensure all panels fit together correctly before marking the perimeter.



03.

Remove the shower base and prime within the marked area. For porous substrates use Cureflex™ PG57 primer and for non-porous substrates use Cureflex™ LS151 primer. Please refer to manufacturer's recommendations.

Apply a minimum of 2 coats allowing 10 to 15 minutes between coats. The surface will become darker in colour and tacky to the touch when dry.



INSTALLATION STEPS

04.

PVC flashing is required around the perimeter of the shower base where stud framing is present.

Measure and cut the base of the PVC flashing, **70mm** longer for hob waterstop applications *OR* **20mm** longer for aluminium waterstop applications, than the length of the shower base.

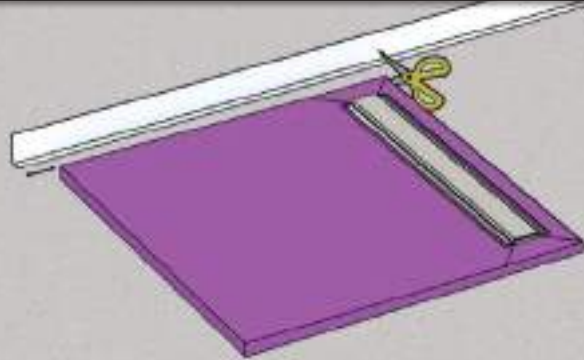

05.

To create a continuous corner make an adjoining cut at a 45° angle, discarding the triangular cut-out.

Fold the PVC flashing back and forth on itself repeatedly to create a vertical crease, indicated by the dotted line.

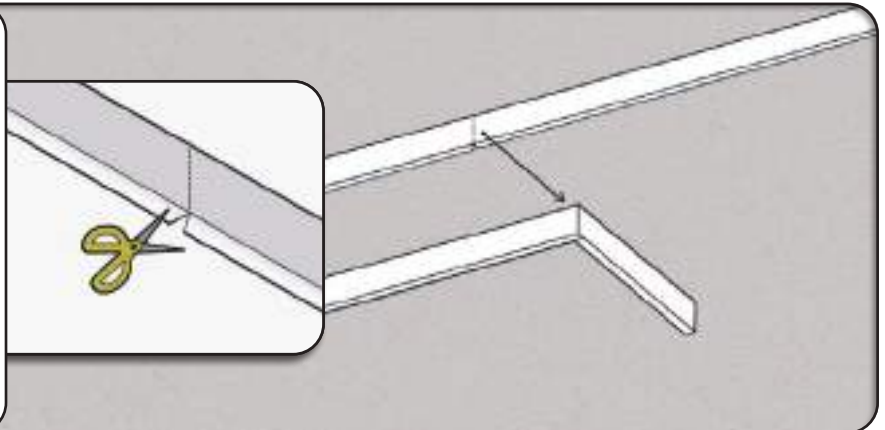

06.

Fold the PVC flashing in on itself to create a right angle ensuring that all internal corners are formed as one continuous piece, as shown here.

PVC flashing is never to be butted together to complete the shower base perimeter.



INSTALLATION STEPS

07.

If necessary, PVC flashing can be overlapped to complete the perimeter. Ensure any pieces overlap by at least **50mm** and the overlap occurs between two studs, as shown here.

Also ensure the PVC flashing extends past the marked/primed area by **70mm** for hob waterstop applications *OR* **20mm** for aluminium waterstop applications.



08.

Dry fit the PVC flashing and shower base, then measure and cut the waterstop(s) to the correct length(s).

Ensure the waterstop(s) is/are prepared correctly. See **Pgs. 3-4** for shower base design variations.

Remove the channel protector and cover plate kit from within the linear channel before continuing.



09.

With all of the components in place, measure and mark the position of the Nero™ Delta Drain (or sleeve extension in first floor applications, if applicable) on either the PVC flashing or stud framing.

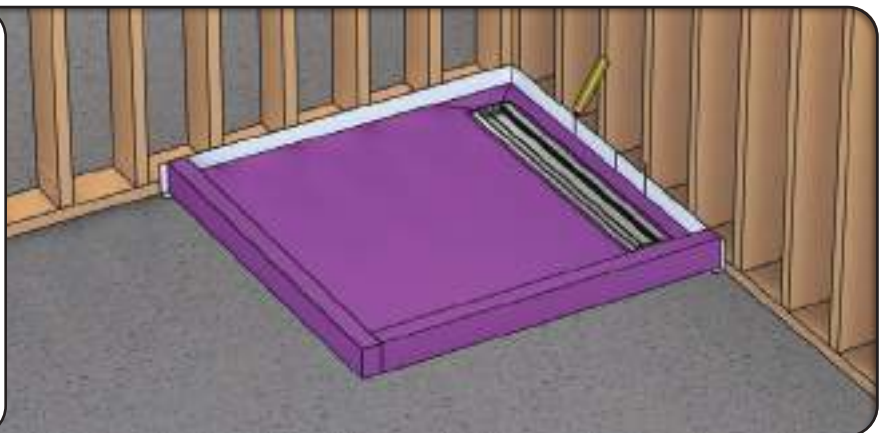

INSTALLATION STEPS

10.

Place the drill guide within the linear channel in the centre of the markings.

Proceed to drill a pilot hole through the linear channel, shower base and into the Nero^M Delta Drain (or sleeve extension in first floor applications, if applicable).



11.

Remove the shower base from the area and place in a safe, level and appropriate position.

Using a **51mm** hole saw drill a hole where marked through both the linear channel and shower base.

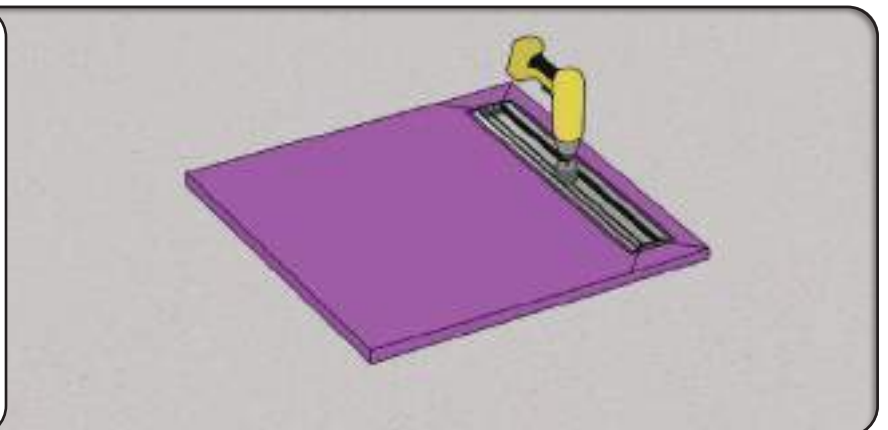

12.

The appropriate sleeve and grommet combination needs to be installed into the substrate.

Refer to the sleeve and grommet installation process on **Pgs. 15-12** for application specific directions.



INSTALLATION STEPS

13.

Remove everything from the area including the sleeve extension lid if applicable.

Proceed to install the PVC flashing using two continuous beads of Cureflex™ HV124 silane, one underneath and the other behind where the PVC flashing will sit, as shown here.



14.

Where overlaps occur, ensure two continuous beads of silane are applied vertically between the PVC flashing, as shown here.

Push the PVC flashing down firmly and smooth over any excess silane using a spatula tool before continuing.



15.

To attach the pipe outlet to the linear channel, place the pipe outlet in reverse through the drilled hole on the underside of the shower base.

Proceed to mark around the top of the pipe outlet on the shower base with a pencil or marker.

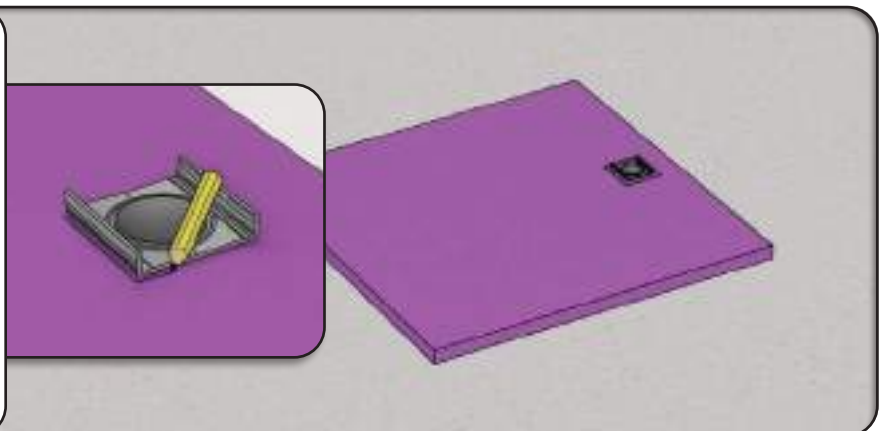

INSTALLATION STEPS

16.

Remove the pipe outlet and cut out the marked square using a utility knife. Remove the square as cleanly as possible and keep aside. DO NOT throw away.

Clean up any excess cured silane (from factory channel installation) that may be present and use a deburring tool to smooth/clean the rough hole saw edges.

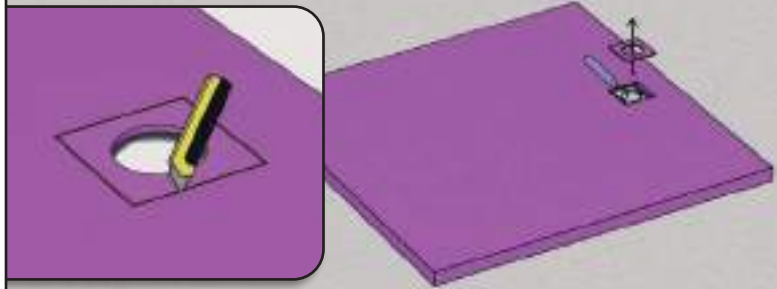

17.

Apply two continuous beads of silane on top of the pipe outlet, as shown here.

Secure the pipe outlet in place on the underside of the linear channel using a punch tool. The components will click together and become locked in place.

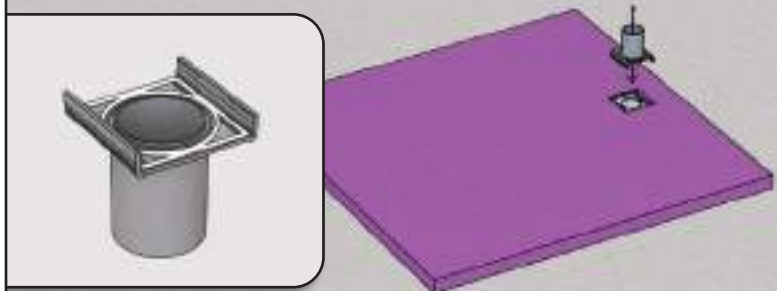

18.

Apply a continuous bead of silane on top of the square cut-out and re-install on the underside of the shower base.

Apply another continuous bead of silane around the square cut-out on the underside of the shower base.

If the square cut-out is damaged or unusable, throw away and fill the open void completely with silane.

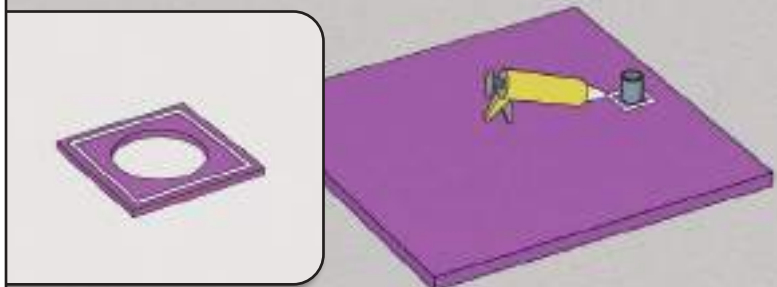

INSTALLATION STEPS

19.

Follow the Cureflex™ TX88 tile adhesive instructions to create a mixture with the desired consistency for the application.



20.

Use a 12mm notched trowel to spread the tile adhesive mixture evenly within the shower base area.

Ensure a 20mm space is present between the base of the PVC flashing, the marked perimeter and the tile adhesive. This will prevent the adhesive from oozing out from under the shower base.



21.

Install the shower base within the marked perimeter on top of the tile adhesive. Apply even pressure across the shower base to ensure the adhesive bonds well and provides maximum adhesion.

If applicable, refer to the split shower base installation process on Pgs. 21-22 for application specific directions.



INSTALLATION STEPS

22.

Check the level of the shower base in multiple areas and make any necessary adjustments before continuing.

Ensure the fall ratio is not compromised and meets the required standard.

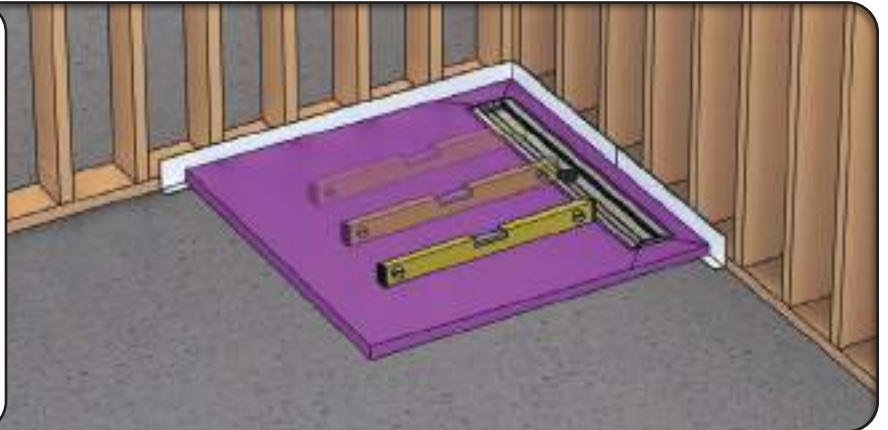

23.

Install the waterstop(s) in the same way as the PVC flashing using two continuous beads of silane, one underneath and the other behind where the waterstop(s) will sit, as shown here.

For hob waterstop applications, skip to **Step 25**. For aluminium waterstop applications follow **Step 24**.

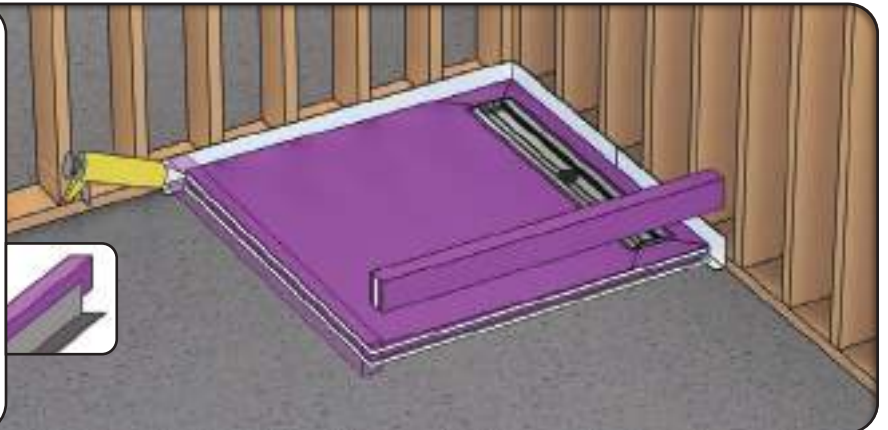

24.

In aluminium waterstop applications, aluminium collars are required in all discontinuous corners. Apply two continuous beads of silane on both back sides of the collar, as shown here.

Push the collars down between the shower base and PVC flashing/waterstop until they sit level and flush.

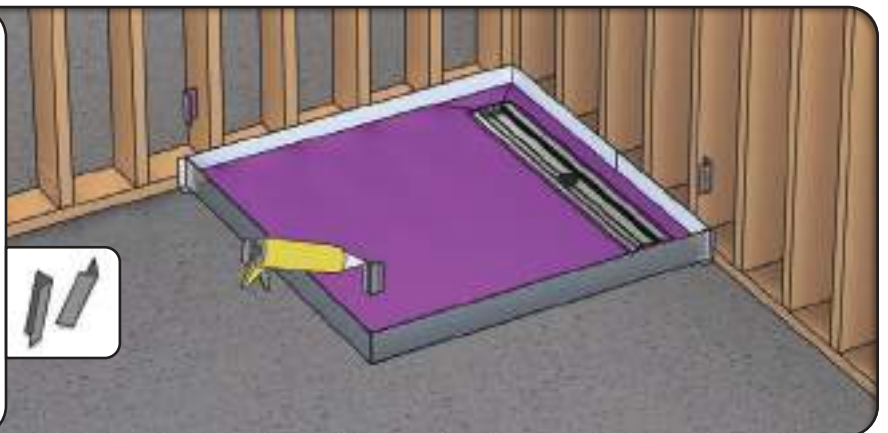

LINEAR GRATE SHOWER BASE

INSTALLATION STEPS

25.

For any substrate* other than a concrete slab, secure the shower base to the substrate using **75mm** hex drive screws, as shown here.

If applicable, refer to the split shower base installation process on **Pgs. 21-22** for application specific directions.



26.

Silane the internal perimeter of the shower base to the PVC flashing and waterstop(s), as shown here.

If applicable, silane any shower base panel joins and exposed screw heads. Smooth over any excess silane using a spatula tool.



27.

Silane the external perimeter of the waterstop(s) to the substrate, as shown here. Smooth over any excess silane using a spatula tool.

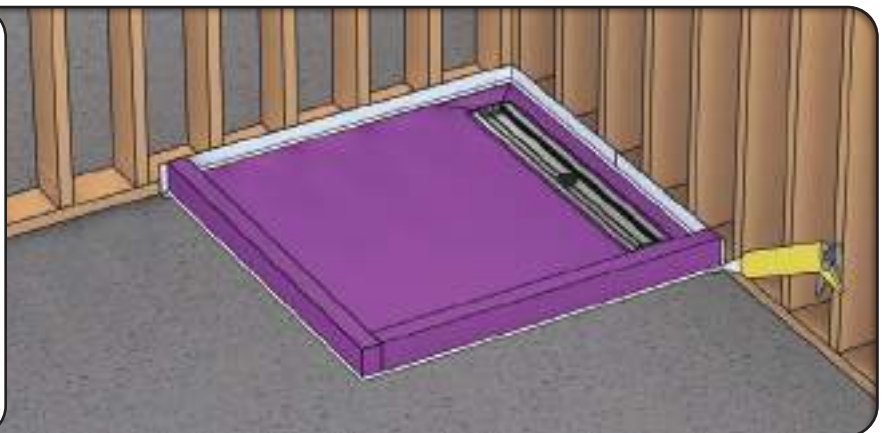

*PLEASE NOTE: Ensure substrate is complete, fully supported and installed as per manufacturer's recommendations.

INSTALLATION STEPS

28.

Re-install the cover plate kit within the linear channel and slide the protective cover back over the top.

The protective cover is not to be removed until after tiling of the shower base has been completed.



29.

Place the protective matting over the shower base and use the barrier tape and warning sign to prevent entry into the area.

Allow a minimum of **48 hours** before traffic to allow for sufficient curing of adhesive/sealant products.



SLEEVE & GROMMET

01.

Following on from **Step 12** of the installation process, a pilot hole in the Nero[™] Delta Drain will mark where the sleeve and grommet will be installed.



02.

Using an **83mm** hole saw drill a hole where marked into the plastic/structural lid of the Nero[™] Delta Drain.



03.

Install a **50mm** Sleeve into the Nero[™] Delta Drain using one continuous bead of silane underneath, as shown here.



LINEAR GRATE SHOWER BASE

SLEEVE & GROMMET

GROUND FLOOR DESIGN VARIATION

04.

Secure the Sleeve to the Nero™ Delta Drain using **25mm** wood screws.



05.

Place a **50mm** Grommet within the Sleeve and ensure the Grommet remains within the Sleeve during the installation.



06.

The shower base can now be installed over the top of the plumbing fittings.



SLEEVE & GROMMET

01.

Following on from **Step 12** of the installation process, a pilot hole in the substrate* will mark where the sleeve extension and grommet will be installed.



02.

Using an **83mm** hole saw drill a hole where marked into the substrate.



03.

Install a **50mm** Sleeve Extension into the substrate using one continuous bead of silane underneath, as shown here.



*PLEASE NOTE: Ensure substrate is complete, fully supported and installed as per manufacturer's recommendations.

LINEAR GRATE SHOWER BASE

SLEEVE & GROMMET

FIRST FLOOR DESIGN VARIATION

04.

Secure the Sleeve Extension to the substrate using **25mm** wood screws.



05.

Place a **50mm** Grommet within the Sleeve Extension and ensure the Grommet remains within the Sleeve Extension during the installation.



06.

The shower base can now be installed over the top of the plumbing fittings.



SLEEVE & GROMMET

01.

In some cases a **100mm** Sleeve Extension may already be installed in the substrate*.

Following on from **Step 12** of the installation process, a pilot hole in the sleeve extension will mark where the sleeve and grommet will be installed.



02.

Using an **83mm** hole saw drill a hole where marked into the plastic lid of the Sleeve Extension.



03.

Install a **50mm** Sleeve into the Sleeve Extension using one continuous bead of silane underneath, as shown here.



*PLEASE NOTE: Ensure substrate is complete, fully supported and installed as per manufacturer's recommendations.

LINEAR GRATE SHOWER BASE

SLEEVE & GROMMET

FIRST FLOOR DESIGN VARIATION

04.

Place a **50mm** Grommet within the Sleeve and ensure the Grommet remains within the Sleeve during the installation.



05.

The shower base can now be installed over the top of the plumbing fittings.



LINEAR GRATE SHOWER BASE

TONGUE & GROOVE

SPLIT SHOWER BASE DESIGN VARIATION

01.

Sometimes a shower base may be made up of two or more panels. These panels must be correctly joined when installing the shower base.



02.

Set the first panel down on top of the tile adhesive and apply a continuous bead of silane along the length of the groove, as shown here.



03.

On the adjoining panel, apply a continuous bead of silane along the length of the tongue, as shown here.



TONGUE & GROOVE

04.

Ensure all panels are installed securely with the tongue pressed firmly into the groove. Smooth over any excess silane using a spatula tool.

Apply even pressure across the entire shower base to ensure the adhesive bonds well and provides maximum adhesion.



05.

For any substrate* other than a concrete slab, secure the base to the substrate using **75mm** hex drive screws.

Screws must be fixed in accordance with the installation process. Screws must also be fixed **300mm** apart along the length of the rebate between panels.

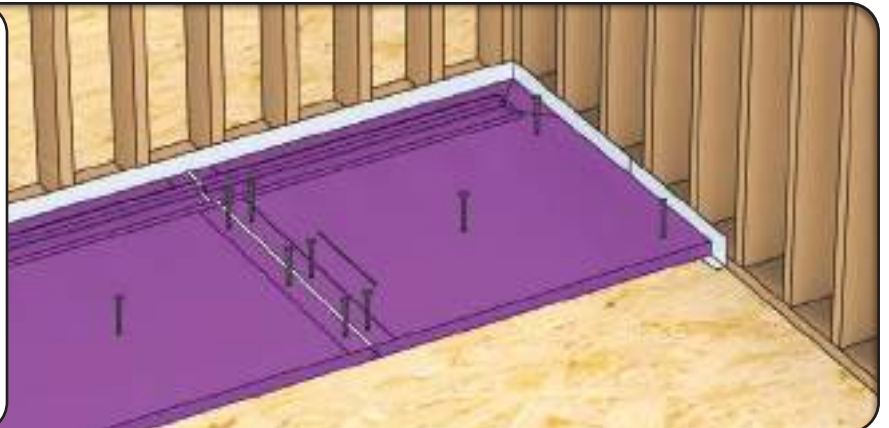

*PLEASE NOTE: Ensure substrate is complete, fully supported and installed as per manufacturer's recommendations.

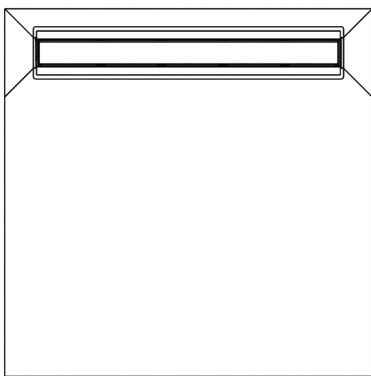
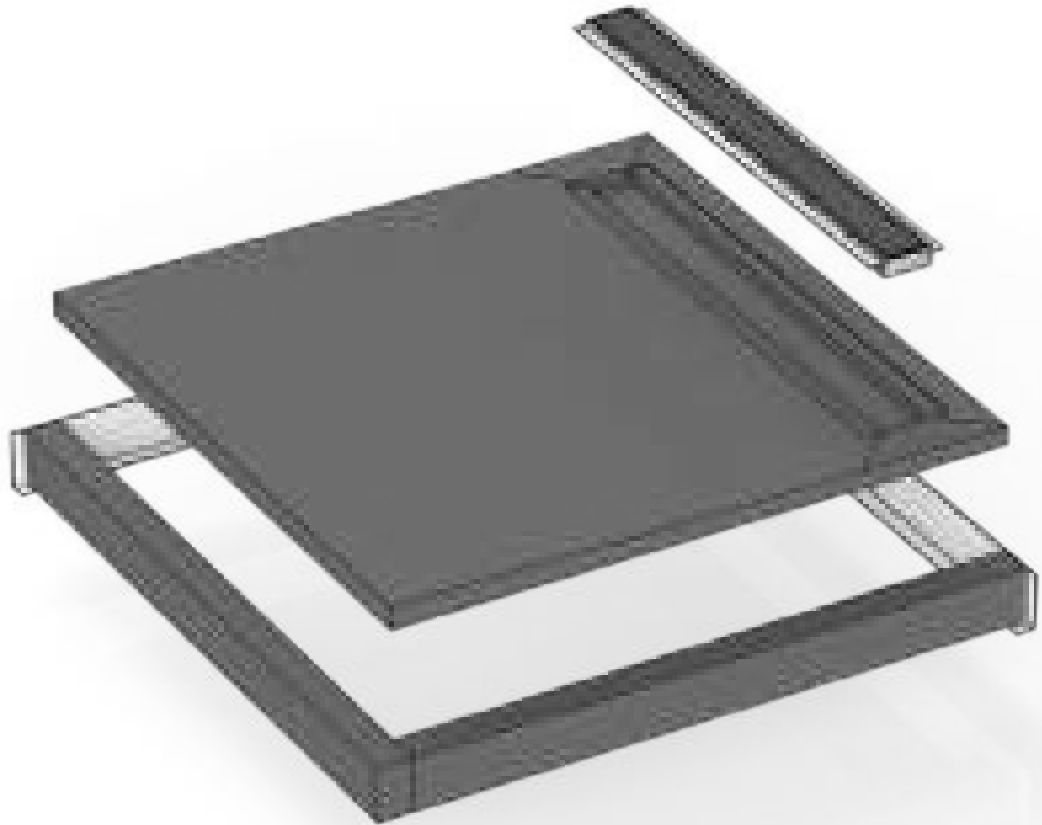

LINEAR GRATE SHOWER BASE

INSTALLATION GUIDE

